

# Tekform Slimline Drawer DW70

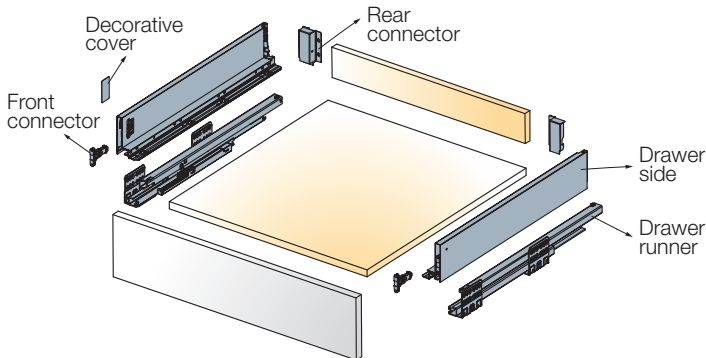

## Cutting dimensions details

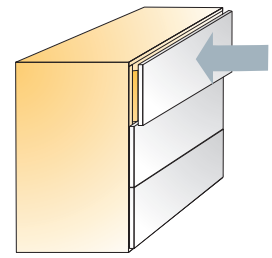
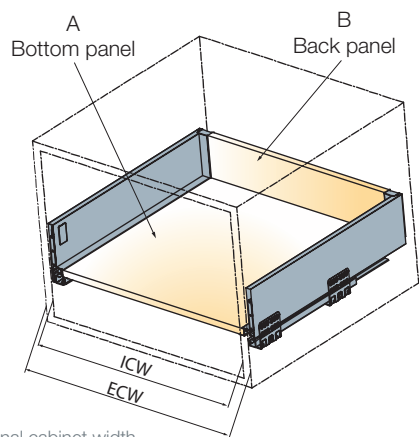

ECW: External cabinet width  
ICW: Internal cabinet width  
NL: Nominal length of drawer

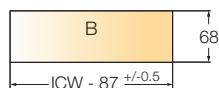
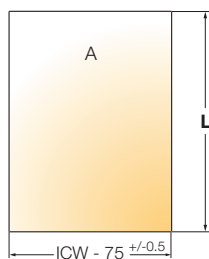

$L = NL - 10$   
For further explanation → see page 9

 4 sets

Nominal length (mm)	with EasyFix front connector	with Screw-in front connector		
	Item number for a set	Item number for a set	White	Antracite grey

270	655-8T27 →	655-8E27 →	150	185
300	655-8T30 →	655-8E30 →	150	185
350	655-8T35 →	655-8E35 →	150	185
400	655-8T40 →	655-8E40 →	150	185
450	655-8T45 →	655-8E45 →	150	185
500	655-8T50 →	655-8E50 →	150	185
550	655-8T55 →	655-8E55 →	150	185

## One set consists of

Drawer sides  2 pcs

Drawer runners  2 pcs

\*Front connectors  2 pcs

Rear connectors  2 pcs

Covers  2 pcs

Covers  2 pcs

Mounting instructions  1 pc

Screws are not included

- Drawer runner type
- Load capacity
- Minimum height space required
- Wooden back panel thickness
- Wooden bottom panel thickness

full extension  
40 kg  
115mm  
16mm  
16mm

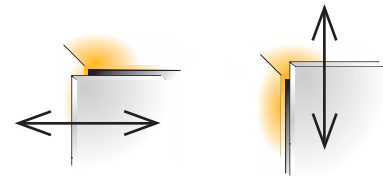

Side adjustment  
+1/-1mm

Height adjustment  
+2/-2mm

For further explanation → see page 11

Installation dimensions

Minimum space required for the cabinet

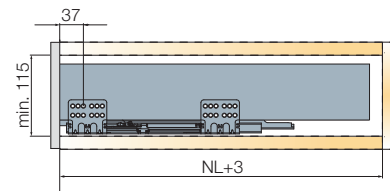

Drilling dimensions for the front panel

EasyFix attachment

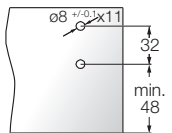

Screw-in attachment

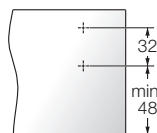

Mounting dimensions for the back panel

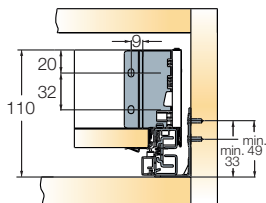

Installation dimensions for the front panel

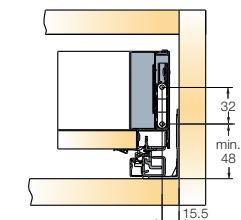

Drawer runner fixing positions

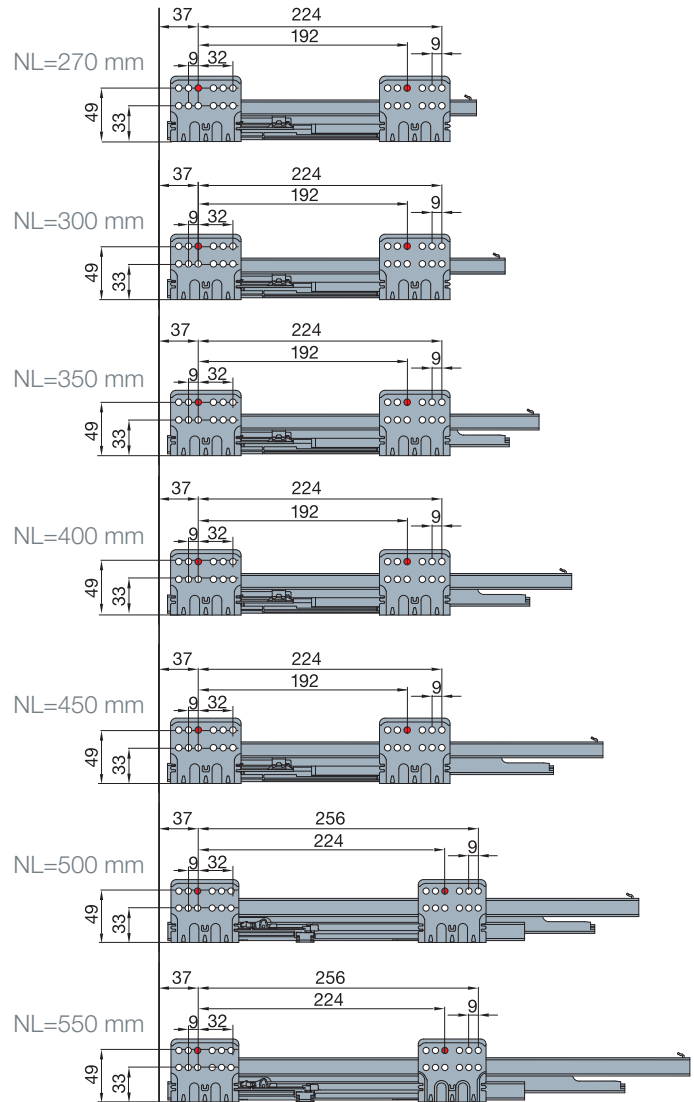
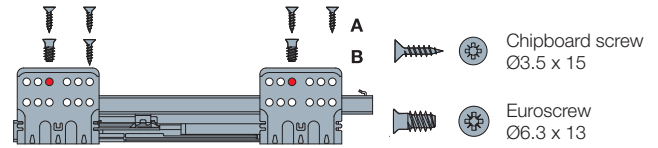

A trial mounting is always recommended.  
For further information please contact your  
Titus Group representative.